

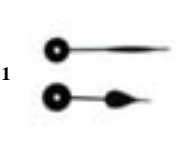

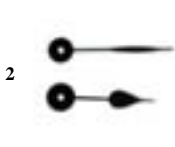



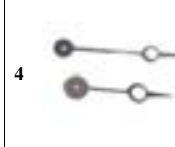

6. Hands

Metal hands for French, English & American clocks. Public clock hands, collets and washers.

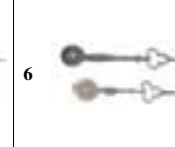
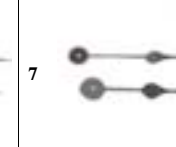
CARRIAGE CLOCK HANDS

Size is centre to tip of minutes hand. Supplied blued with centre hole (1.5mm unless stated), and made with spring steel for added strength. If modifications are required, softening can be achieved by heating, then allowing to cool.

						
				Call Harvey for Postage free delivery* * Conditions apply	Call HARVEY on 0800 328 9435	M & P Key Suppliers to Clockmakers

			Price per unit in £ on 13/06/2014	
1	CARRIAGE CLOCK HANDS: 25mm (Uncolleted)	0348 002515	1+	£9.64
2	CARRIAGE CLOCK HANDS: 30mm (Uncolleted)	0348 003015	1+	£9.64
3	CARRIAGE CLOCK HANDS - MOON: 25mm (Uncolleted)	1604 002515	1+	£10.44
4	CARRIAGE CLOCK HANDS - MOON: 30mm (Uncolleted)	1604 003015	1+	£10.44
5	CARRIAGE CLOCK HANDS - TREFLE: 25mm (Uncolleted)	1605 002515	1+	£10.44
6	CARRIAGE CLOCK HANDS - TREFLE: 30mm (Uncolleted)	1605 003015	1+	£10.44
7	CARRIAGE CLOCK HANDS - SPADE: 25mm (Uncolleted)	1606 002515	1+	£10.44
8	CARRIAGE CLOCK HANDS - SPADE: 30mm (Uncolleted)	1606 003015	1+	£10.44
9	CARRIAGE CLOCK HANDS - FLEUR DE LYS: 25mm (Uncolleted)	1607 002515	1+	£10.44
10	CARRIAGE CLOCK HANDS - FLEUR DE LYS: 30mm (Uncolleted)	1607 003015	1+	£10.44
11	CARRIAGE CLOCK HANDS - BREGUET DESIGN: 21.5MM Minute hand 21.5mm, hour hand 16.5mm. Blued and holed only - min hand hole: 2.25mm, hour hand hole: 3.5mm.	1608 002315	1+	£11.60

CARRIAGE CLOCK ALARM CALENDER HAND

Size is centre to tip. Supplied blued and made out of spring steel for added strength. If modifications are required, softening can be achieved by heating, then allowing to cool.

Price per unit in £ on 13/06/2014

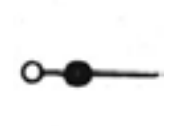
	CARRIAGE CLOCK HAND - Alarm calender: 10mm Length given is centre to tip. Overall length is 14mm. Tail to centre 6mm, centre to tip 8mm.	1608 000815	1+	£10.44
--	---	--------------------	----	---------------

VIENNA CLOCK HANDS

				Buy Online @ www.m-p.co.uk	Call Harvey 24 Hours	Call Harvey our Automated Sales line
---	---	---	---	---	-----------------------------------	---

			Price per unit in £ on 13/06/2014	
1	VIENNA CLOCK HANDS 65mm Colleted for 4.5mm round hour and 2mm square minute shaft. 65mm minute length.	0448 006515	1+	£8.32
2	VIENNA CLOCK SECOND HAND Second hand with pipe.	0448 000115	1+	£10.54
3	VIENNA CLOCK HANDS 85mm Colleted for 4.5mm round hour and 2mm square minute shaft. 85mm minute length.	0448 008515	1+	£9.09

FRENCH CLOCK HANDS SPADE

Colleted. 0.5mm steel, blued. Hour hole 6mm. Minute hole 4.5mm.

Price per unit in £ on 13/06/2014

	FRENCH CLOCK HANDS SPADE 30mm	0308 003015	1+	£10.13
	FRENCH CLOCK HANDS SPADE 35mm	0308 003515	1+	£10.80
	FRENCH CLOCK HANDS SPADE 40mm	0308 004015	1+	£11.23
	FRENCH CLOCK HANDS SPADE 45mm	0308 004515	1+	£11.90
	FRENCH CLOCK HANDS SPADE 50mm	0308 005015	1+	£12.33
	FRENCH CLOCK HANDS SPADE 60mm	0308 006015	1+	£13.00
	FRENCH CLOCK HANDS SPADE 70mm	0308 007015	1+	£14.10
	FRENCH CLOCK HANDS SPADE 40mm GILT	0308 004018	1+	£15.70
	FRENCH CLOCK HANDS SPADE 50mm GILT	0308 005018	1+	£15.70
	FRENCH CLOCK HANDS SPADE 60mm GILT	0308 006018	1+	£15.70

FRENCH CLOCK MINUTE HAND ONLY - SPADE

Colleted. 2mm steel, blued.

Price per unit in £ on 13/06/2014

	FRENCH CLOCK MINUTE HAND SPADE 30mm	0308 103015	1+	£5.99
	FRENCH CLOCK MINUTE HAND SPADE 40mm	0308 104015	1+	£5.99
	FRENCH CLOCK MINUTE HAND SPADE 70mm	0308 107015	1+	£5.99

Up-to-date Prices Online

This catalogue contains trade prices correct at the time of publication. You can view and download this catalogue with current prices online.

6. Hands

FRENCH CLOCK HANDS MOON

Colleted. 0.5mm steel, blued. Hour hole 6mm. Minute hole 4.5mm.

Price per unit in £ on 13/06/2014

	FRENCH CLOCK HANDS MOON 28mm	0309 002815	1+	£11.23
	FRENCH CLOCK HANDS MOON 35mm	0309 003515	1+	£11.90
	FRENCH CLOCK HANDS MOON 40mm	0309 004015	1+	£12.33
	FRENCH CLOCK HANDS MOON 45mm	0309 004515	1+	£13.00
	FRENCH CLOCK HANDS MOON 50mm	0309 005015	1+	£13.44
	FRENCH CLOCK HANDS MOON 60mm	0309 006015	1+	£14.10

FRENCH CLOCK HANDS FLEUR DE LYS

Colleted. 0.5mm steel, blued. Hour hole 6mm. Minute hole 4.5mm.

Price per unit in £ on 13/06/2014

	FRENCH CLOCK HANDS FLEUR DE LYS 30mm	0310 003015	1+	£13.00
	FRENCH CLOCK HANDS FLEUR DE LYS 35mm	0310 003515	1+	£13.44
	FRENCH CLOCK HANDS FLEUR DE LYS 40mm	0310 004015	1+	£14.10
	FRENCH CLOCK HANDS FLEUR DE LYS 50mm	0310 005015	1+	£14.54
	FRENCH CLOCK HANDS FLEUR DE LYS 60mm	0310 006015	1+	£15.21

FRENCH CLOCK HANDS, LOUIS XV

Hour: Brass collet with internal 4.5mm hole. Minute: Brass collet with 1.9mm square hole. Length is minute length. Gilt Steel.

Price per unit in £ on 13/06/2014

	FRENCH CLOCK HANDS LOUIS XV 25mm GILT	0786 002518	1+	£16.84
	FRENCH CLOCK HANDS LOUIS XV 39mm GILT	0786 003918	1+	£16.84

TREFLE HANDS FOR FRENCH CLOCK













Colleted. 0.5mm steel, blued. Hour hole 6mm. Minute hole 4.5mm.

Price per unit in £ on 13/06/2014

	TREFLE HANDS FOR FRENCH CLOCKS, 30mm BLUE	0311 003015	1+	£11.90
	TREFLE HANDS FOR FRENCH CLOCKS, 35mm BLUE	0311 003515	1+	£12.33
	TREFLE HANDS FOR FRENCH CLOCKS, 40mm BLUE	0311 004015	1+	£13.00
	TREFLE HANDS FOR FRENCH CLOCKS, 50mm BLUE	0311 005015	1+	£13.44
	TREFLE HANDS FOR FRENCH CLOCKS, 60mm BLUE	0311 006015	1+	£14.10
	TREFLE HANDS FOR FRENCH CLOCKS, 65mm BLUE	0311 006515	1+	£14.54

LONGCASE HANDS

Sold in pairs, except seconds hands.

1 	2 	3 	4 	5 	6 	7 
8 	9 	10 	11 		Call Harvey for Same day dispatch*	
						* Conditions apply

Price per unit in £ on 13/06/2014

1 LONGCASE HANDS, STEEL PAINTED BLACK Serpentine hands for mass-produced clocks. Minute length 6".	0288 000202	1+	£3.67
		2+	£3.30
2 LONGCASE SECOND HAND PLAIN, SOLID BRASS Second hand for mass-produced clocks. With pipe.	0289 000118	1+	£5.19
3 LONGCASE SECOND HAND PLAIN, PAINTED STEEL Second hand for mass-produced clocks. With pipe. Black painted steel.	0289 000102	1+	£4.68
4 HIGH QUALITY LONGCASE STEEL HANDS Beautifully cut from 20g. steel (1.2mm), ready for filing & blueing. Minute hand 5" Hour hand 3 3/8".	0707 000114	1+	£34.57
5 HIGH QUALITY LONGCASE STEEL SECOND HAND Beautifully cut from 20g. steel (1.2mm), ready for filing & blueing. Second hand (no pipe).	0707 000214	1+	£10.96
6 LONGCASE SECOND HAND FANCY, PAINTED STEEL Second hand for mass-produced clocks. With pipe. Black painted steel.	0289 000202	1+	£5.45
7 LONGCASE SECOND HAND FANCY, SOLID BRASS Second hand for mass-produced clocks. With pipe.	0289 000218	1+	£7.14
8 HIGH QUALITY LONGCASE BRASS HANDS Cut from brass and the surface stamped. Minute length 6".	0763 000218	1+	£50.16
9 HIGH QUALITY LONGCASE BRASS SECOND HAND Cut from brass and the surface stamped.	0763 000118	1+	£24.05
10 BLACK, BRASS MACHINE CUT LONGCASE HANDS 100mm Minute hand. 75mm Hour hand.	1430 010002	1+	£13.63
11 BLACK, BRASS STAMPED HANDS Minute hand 120mm. Hour hand 90mm.	1431 012002	1+	£13.63

ZAMDAAM CLOCK HANDS

Price per unit in £ on 13/06/2014

	ZAANDAM CLOCK HANDS 60mm BRASS Cast brass hands. Minute hands 60mm, hour hand 40mm.	1169 000118	1+	£18.51
--	--	--------------------	----	---------------

6. Hands

NAPOLEON CLOCK HANDS

Price per unit in £ on 13/06/2014

	NAPOLEON CLOCK HANDS 69mm. Black steel hands for Napoleon and other mass-produced movements requiring a strong pair of hands. Minute hand 69mm from centre to tip. Hour hand 53mm. Hour collet 4.4mm diameter, but could be enlarged to 4.8mm. Minute collet 2mm sq. which could be filed out to 3mm.	0790 006902	1+	£7.31

STEEL ENGLISH DIAL HANDS

Un-colleted quality steel hands. Painted black. Pilot hole. Length is minute hand length from centre to tip. Styles may vary.

Price per unit in £ on 13/06/2014

	STEEL ENGLISH 12" DIAL HANDS Standard type suitable for 12" dials. 5 3/4" from centre to tip.	0320 001215	1+	£5.44
			3+	£4.90
			Pack of 10	£4.62
	STEEL ENGLISH DIAL HANDS 90mm Slender type.	0320 009015	1+	£5.44
	STEEL ENGLISH DIAL HANDS 110mm Slender type.	0320 011015	1+	£5.94
	STEEL ENGLISH DIAL HANDS 123mm Slender type.	0320 012315	1+	£6.55
	STEEL ENGLISH DIAL HANDS 130mm Slender type.	0320 013015	1+	£7.04
	STEEL ENGLISH DIAL HANDS 140mm Slender type.	0320 014015	1+	£7.65

BLACK FOREST CLOCK HANDS

Cast brass. Dimension is minute length.

Price per unit in £ on 13/06/2014

	BLACK FOREST CLOCK HANDS 82mm	0601 008215	1+	£17.46
	BLACK FOREST CLOCK HANDS 110mm	0601 011015	1+	£29.68
	BLACK FOREST CLOCK HANDS 125mm	0601 012515	1+	£22.80

CUCKOO CLOCK HANDS ASSORTED

White plastic.



Price per unit in £ on 13/06/2014

	CUCKOO CLOCK HANDS ASSORTMENT A, 8 pairs. 2 pairs of hands of each size: 28/23mm, 36/32mm, 43/32mm and 48/42mm long.	0409 284815	1+	£11.74
	CUCKOO CLOCK HANDS ASSORTMENT B, 6 pairs. 2 pairs of hands of each size: 63/49mm, 70/55mm and 86/67mm long.	0409 638615	1+	£21.65

GERMAN CLOCK HANDS

Minute length 70mm. Collets 4.5mm round and 2.5mm square.

Price per unit in £ on 13/06/2014

	GERMAN CLOCK HANDS BRASS	0400 000118	1+	£6.55
	GERMAN CLOCK HANDS BLACK Steel.	0400 000102	1+	£6.55

O.G. HANDS

Price per unit in £ on 13/06/2014

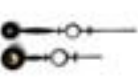
	O.G. HANDS Hour hand bushed. 3 1/2" from centre to tip. Suitable for 7"-7 1/2" dials.	0220 070015	1+	£7.27

SETH THOMAS HANDS

Price per unit in £ on 13/06/2014

	SETH THOMAS HANDS With the S & T forming part of the hands. Bushed hour hand with square minute hole. 2 5/8" from centre to tip. Suitable for 5" dials.	0471 000515	1+	£7.18

AMERICAN CALENDAR HANDS

Dimension is from centre to tip. Unbushed.

Price per unit in £ on 13/06/2014

	AMERICAN CALENDAR HANDS 2 1/2" UNBUSHED	0521 025015	1+	£3.96
	AMERICAN CALENDAR HANDS 4 1/2" UNBUSHED	0521 004515	1+	£3.96

Up-to-date Prices Online

This catalogue contains trade prices correct at the time of publication. You can view and download this catalogue with current prices online.

6. Hands

TERRY HANDS

Price per unit in £ on 13/06/2014

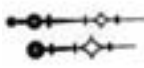
	TERRY HANDS Unbushed hands typical of the style used on Terry Clocks. 4 1/2" from centre to tip. Suitable for 9" time tracks.	0470 001115	1+	£9.07
--	--	--------------------	----	--------------

MALTESE CROSS HANDS

Black finish. Size given is the chapter ring diameter. Styles may vary according to availability. Some sizes may be collected.

Price per unit in £ on 13/06/2014

	MALTESE CROSS HANDS 4"	0429 000415	1+	£4.15
	MALTESE CROSS HANDS 5" (Colleted)	0429 000515	1+	£4.32
	MALTESE CROSS HANDS 7" (Uncolleted)	0429 000715	1+	£3.94
	MALTESE CROSS HANDS 9" (Uncolleted)	0429 000915	1+	£4.19
	MALTESE CROSS HANDS 11" (Colleted)	0429 001115	1+	£4.90

REGULATOR A HANDS

Price per unit in £ on 13/06/2014

	REGULATOR A' HANDS (Colleted) A copy of the Ansonia 'A' regulator hands. Will fit 11" chapter rings. 1880's style.	0655 001115	1+	£7.18
--	---	--------------------	----	--------------

BANJO HANDS

Price per unit in £ on 13/06/2014

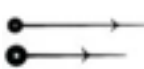
	BANJO HANDS (Uncolleted) Suits 7" chapter ring.	0428 000115	1+	£15.27
--	--	--------------------	----	---------------

AMERICAN REGULATOR SECOND HAND

Price per unit in £ on 13/06/2014

	AMERICAN REGULATOR SECOND HAND With pipe. 45mm centre to tip. 15mm pipe.	0469 021215	1+	£4.84
--	---	--------------------	----	--------------

LARGE STEEL SPADE HANDS

A range of steel hands for public clocks behind glass. Minute hand has a tail suitable for counter-balancing if necessary. 0.5mm thick. No pilot hole. Not suitable for use if exposed to the weather, as rusting will occur. Use our stainless hands for that purpose. Length is centre to tip.

Price per unit in £ on 13/06/2014

	LARGE STEEL SPADE HANDS 155mm Tail length 60mm.	0990 001215	1+	£17.81
	LARGE STEEL SPADE HANDS 185mm Tail length 70mm.	0990 001415	1+	£24.18
	LARGE STEEL SPADE HANDS 210mm Tail length 77mm.	0990 001615	1+	£28.00
	LARGE STEEL SPADE HANDS 238mm Tail length 87mm.	0990 001815	1+	£30.35
	LARGE STEEL SPADE HANDS 257mm Tail length 97mm.	0990 002015	1+	£33.10
	LARGE STEEL SPADE HANDS 298mm Tail length 110mm.	0990 002415	1+	£35.01
	LARGE STEEL SPADE HANDS 385mm Tail length 145mm.	0990 003015	1+	£38.19
	LARGE STEEL SPADE HANDS 465mm Tail length 177mm.	0990 003615	1+	£38.19

COMTOISE MORBIER HANDS

Cut from 8/10mm solid brass. Either polished or antique finished hands. Punched centres. Top quality. Minute length centre to tip.

1 	2 	3 	Call Harvey for Postage free delivery* * Conditions apply	Call HARVEY on 0800 328 9435	M & P Key Suppliers to Clockmakers	
--	---	---	---	-------------------------------------	---	---

Price per unit in £ on 13/06/2014

1	COMTOISE MORBIER HANDS PLAIN Polished. Minute length 116mm. Surface plain.	1074 011618	1+	£17.52
			2+	£16.64
2	ANTIQUÉ COMTOISE HANDS HANDCUT Minute length 116mm. Surface plain.	1074 216015	1+	£17.52
			2+	£16.64
3	COMTOISE MORBIER HANDS STAMPED Polished. Minute length 110mm. Surface stamped.	1074 011018	1+	£17.52
			2+	£16.64

MORBIER BRASS HANDS

Cut from 8/10mm solid brass. Either polished or antique finished hands. Punched centres. Top quality. Minute length centre to tip.

Price per unit in £ on 13/06/2014

	MORBIER BRASS HANDS 116mm POLISHED Surface plain.	1119 116018	1+	£16.41
			2+	£15.59

6. Hands

	MORBIER BRASS HANDS 116mm ANTIQUE Surface plain.	1119 011615	1+	£16.41
			2+	£15.59

ANTIQU MORBIER HANDS







Cut from 0.8mm solid brass. Either polished or antique finished hands. Punched centres. Top quality. Minute length centre to tip.

Price per unit in £ on 13/06/2014

	BRASS MORBIER HANDS Minute : 116mm, Hour : 80mm, Stamped.	1099 116018	1+	£17.52
			2+	£16.64
	ANTIQU MORBIER HAND Minute : 116mm, Hour : 80mm. Stamped.	1099 116015	1+	£17.52
			2+	£16.64











MORBIER BRASS HANDS

Cut from 0.8mm solid brass. Either polished or antique finished hands. Punched centres. Top quality. Minute length centre to tip.

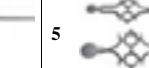
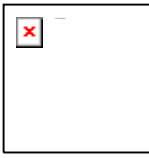
1 	2 	3 	4 	5 	6 	Buy Online @ www.m-p.co.uk		
Price per unit in £ on 13/06/2014								
1 MORBIER BRASS HANDS 116mm POLISHED						1120 116018	1+	£16.41
							2+	£15.59
2 MORBIER BRASS HANDS 116mm ANTIQUE						1120 011615	1+	£16.41
							2+	£15.59
3 MORBIER BRASS HANDS 105mm ANTIQUE						1121 010515	1+	£16.41
							2+	£15.59
4 MORBIER BRASS HANDS 105mm POLISHED						1121 105018	1+	£16.41
							2+	£15.59
5 MORBIER BRASS HANDS 105mm ANTIQUE						1122 010515	1+	£16.41
							2+	£15.59
6 MORBIER BRASS HANDS 105mm POLISHED						1122 105018	1+	£16.41
							2+	£15.59

MORBIER HANDS

Absolutely superb quality hand made steel Morbier hands for "Cockerel Morbier" wall clocks(double convex shape dials). Rusty hands are available, ready to be brushed and painted. Minute length centre to tip.

1 	2 	3 	4 	5 	6 	7 
8 	9 	10 	Call Harvey 24 Hours	Call Harvey our Automated Sales line		Call Harvey for Same day dispatch*
						* Conditions apply

Price per unit in £ on 13/06/2014

1 MORBIER HANDS 135mm UNPOLISHED						1138 000215	1+	£55.00
							2+	£52.25
2 MORBIER HANDS 135mm UNPOLISHED						1139 000315	1+	£55.00
							2+	£52.25
3 MORBIER HANDS 135mm UNPOLISHED						1141 000515	1+	£55.00
							2+	£52.25
4 MORBIER HANDS 145mm UNPOLISHED						1137 000115	1+	£55.00
							2+	£52.25
5 MORBIER HANDS 145mm UNPOLISHED						1140 000415	1+	£55.00
							2+	£52.25
6 MORBIER HANDS, HOUR: 135mm, MINUTE: 65mm. RUSTED. Measured from centre to tip.						1137 100118	1+	£55.00
							2+	£52.25
7 MORBIER HANDS, HOUR: 135mm, MINUTE: 62mm. RUSTED Measured from centre to tip.						1138 200218	1+	£55.00
							2+	£52.25
8 MORBIER HANDS, HOUR: 135mm, MINUTE: 90mm. RUSTED. Measured from centre to tip.						1139 300318	1+	£55.00
							2+	£52.25
9 MORBIER HANDS, HOUR: 135mm, MINUTE: 85mm. RUSTED. Measured from centre to tip.						1140 400418	1+	£55.00
							2+	£52.25
10 MORBIER HANDS, HOUR: 135mm, MINUTE: 62mm. RUSTED. Measured from centre to tip.						1141 500518	1+	£55.00
							2+	£52.25

Up-to-date Prices Online

This catalogue contains trade prices correct at the time of publication. You can view and download this catalogue with current prices online.

6. Hands

STAINLESS STEEL HANDS

Uncolleted stainless hands for exterior use. Counterbalancing maybe needed, depending on the movement. Minute length is centre to tip. Ribbed for additional strength.

Price per unit in £ on 13/06/2014

	STAINLESS STEEL HANDS 200mm Suits our dial 480mm.	1187 020019	1+	£43.97
	STAINLESS STEEL HANDS 260mm Suits our dial 595mm.	1187 026019	1+	£56.71
	STAINLESS STEEL HANDS 375mm Suits our dial 820mm.	1187 037519	1+	£77.05
	STAINLESS STEEL HANDS 410mm Suits our dial 945mm.	1187 041019	1+	£104.61
	STAINLESS STEEL HANDS 530mm Suits our dial 1210mm.	1187 053019	1+	£143.19
	STAINLESS STEEL HANDS 670mm Suits our dial 1500mm.	1187 067019	1+	£187.29

COLLETING & BALANCING 1187 HANDS

Charge for optional colleting & counterbalancing 1187 series hands. This is only applicable if ordered at the same time as an exterior movement.

Price per unit in £ on 13/06/2014

	COLLETING & BALANCING 1187 HANDS 135mm	1018 013515	1+	£41.82
	COLLETING & BALANCING 1187 HANDS 200mm	1018 020015	1+	£48.00
	COLLETING & BALANCING 1187 HANDS 260mm	1018 026015	1+	£89.50
	COLLETING & BALANCING 1187 HANDS 345mm	1018 034515	1+	£52.13
	COLLETING & BALANCING 1187 HANDS 375mm	1018 037515	1+	£52.13
	COLLETING & BALANCING 1187 HANDS 410mm	1018 041015	1+	£60.15
	COLLETING & BALANCING 1187 HANDS 530mm	1018 053015	1+	£93.57
	COLLETING & BALANCING 1187 HANDS 670mm	1018 067015	1+	£105.49

AMERICAN CLOCK HANDS - TYPE A

Length given is the diameter of the dial they suit.

Price per unit in £ on 13/06/2014

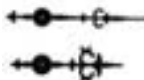
	AMERICAN CLOCK HANDS STYLE A 3 1/2" (Uncolleted)	0217 031215	1+	£7.31
	AMERICAN CLOCK HANDS STYLE A 4 3/4" (Uncolleted)	0217 043415	1+	£8.37

AMERICAN CLOCK HANDS - TYPE B Length given is the diameter of the dial they suit.

Price per unit in £ on 13/06/2014

	AMERICAN CLOCK HANDS STYLE B 3 1/2" (Uncolleted)	0218 031215	1+	£6.62
---	--	-------------	----	-------

AMERICAN CLOCK HANDS - TYPE C Length given is the diameter of the dial they suit.

Price per unit in £ on 13/06/2014

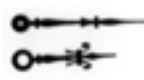
	AMERICAN CLOCK HANDS STYLE C 5" (Uncolleted)	0219 050015	1+	£6.14
--	--	-------------	----	-------

AMERICAN CLOCK HANDS - TYPE D Length given is the diameter of the dial they suit.

Price per unit in £ on 13/06/2014

	AMERICAN CLOCK HANDS STYLE D 5" (Colleted)	0430 000515	1+	£6.80
--	--	-------------	----	-------

AMERICAN CLOCK HANDS - TYPE E

Size given is the diameter of dial they suit.

Price per unit in £ on 13/06/2014

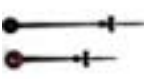
	AMERICAN CLOCK HANDS `E` 3" DIAL Collets supplied for fitting	1427 030015	1+	£6.16
	AMERICAN CLOCK HANDS `E` 3 1/2" DIAL Collets supplied for fitting	1427 031215	1+	£6.22
	AMERICAN CLOCK HANDS `E` 4" DIAL Collets supplied for fitting	1427 040015	1+	£6.28
	AMERICAN CLOCK HANDS `E` 4 1/2" DIAL Collets supplied for fitting	1427 041215	1+	£6.37
	AMERICAN CLOCK HANDS `E` 5" DIAL (Colleted)	1427 050015	1+	£6.42
	AMERICAN CLOCK HANDS `E` 7" DIAL (Colleted)	1427 070015	1+	£6.67

AMERICAN CLOCK HANDS - CALENDAR

Size given is the diameter of dial they suit. Dimension is from centre to tip.

Price per unit in £ on 13/06/2014

	AMERICAN CALENDAR HANDS 4 1/2"	0522 004515	1+	£4.70
--	--------------------------------	-------------	----	-------

AMERICAN CLOCK HANDS - MOON

Size given is the diameter of dial they suit. Steel. Suits chapter ring size shown.

Price per unit in £ on 13/06/2014

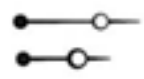
	AMERICAN STYLE MOON HANDS 5" (Uncolleted)	0568 050015	1+	£6.62
	AMERICAN STYLE MOON HANDS 8" (Uncolleted)	0568 080015	1+	£6.67
	AMERICAN STYLE MOON HANDS 11" (Colleted)	0568 110015	1+	£7.31

6. Hands

HANDS FOR QUARTZ CLOCKS - BATON







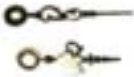

I-shaft fitting. Suitable for clocks using 5mm hour and 2.8 x 3.5mm minute slot. Length is minute hand. Metal.

Price per unit in £ on 13/06/2014

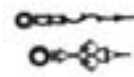
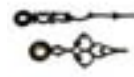
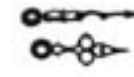
	QUARTZ HANDS, BRASS, 52mm BATON	0473 005218	1+	£1.75
			10+	£1.57
	QUARTZ HANDS, BRASS, 100mm BATON	0473 010018	1+	£5.19
			10+	£4.67
	QUARTZ HANDS, BLACK, 100mm BATON	0473 010002	1+	£2.08
			10+	£1.87
	QUARTZ CLOCK HANDS, BLACK, 200MM Black pointed counterbalanced hands.	0474 020015	1+	£8.75
	QUARTZ CLOCK HANDS, BLACK, 225MM Black counterbalanced hands.	0474 022515	1+	£8.75
			3+	£7.87
			Pack of 10	£6.56
			Pack of 100	£6.12

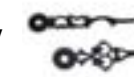
HANDS FOR QUARTZ CLOCKS - SERPENTINE

I-shaft fitting. 5mm hour and 2.8 x 3.5mm minute.

1		2		3		4		5		6		7	
8			Call Harvey for Postage free delivery* * Conditions apply		Call HARVEY on 0800 328 9435		M & P Key Suppliers to Clockmakers			Buy Online @ www.m-p.co.uk			

Price per unit in £ on 13/06/2014

1	QUARTZ HANDS, BRASS, 49mm SERPENTINE	0474 004918	1+	£1.37
			10+	£1.23
2	QUARTZ HANDS, BRASS, 62mm SERPENTINE	0474 006218	1+	£1.37
			10+	£0.96
3	QUARTZ HANDS, BLACK, 62mm SERPENTINE	0474 006202	1+	£1.31
			10+	£1.18
4	QUARTZ HANDS, BRASS, 70mm SERPENTINE	0474 007018	1+	£1.59
			10+	£1.43
5	QUARTZ HANDS, BLACK, 70mm SERPENTINE	0474 007002	1+	£1.31
			10+	£1.18
6	QUARTZ HANDS, BRASS, 76mm SERPENTINE	0474 007618	1+	£2.08
			10+	£1.87
7	QUARTZ HANDS, BLACK, 76mm SERPENTINE	0474 007602	1+	£2.14
			10+	£1.93
8	QUARTZ HANDS, BRASS, 150mm SERPENTINE I-shaft fitting. 5mm hour and 2.8 x 3.5mm.	0474 015018	1+	£3.85

HANDS FOR QUARTZ CLOCKS - FLEUR DE LYS



I-shaft fitting. 5mm hour and 2.8 x 3.5mm minute.

Price per unit in £ on 13/06/2014

	QUARTZ HANDS, BLACK, 42mm FLEUR DE LYS	0474 004202	1+	£4.13
			10+	£3.72
	QUARTZ HANDS, BRASS, 42mm FLEUR DE LYS	0474 004218	1+	£1.45
			10+	£1.30

HANDS FOR QUARTZ CLOCKS - SPADE

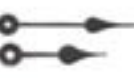
I-shaft fitting. 5mm hour and 2.8 x 3.5mm minute.

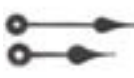
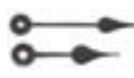
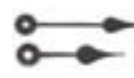
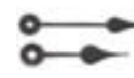
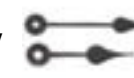
1		2		3		4		5		6		7	
---	---	---	---	---	---	---	---	---	--	---	---	---	---

Price per unit in £ on 13/06/2014

1	QUARTZ HANDS, BLACK, SPADE 55mm	0474 005515	1+	£1.53
			10+	£1.38
2	QUARTZ HANDS, BLACK, SPADE 73mm	0474 007315	1+	£2.61
			10+	£2.35
3	QUARTZ HANDS, BLACK, SPADE 82mm	0474 008215	1+	£2.06
			10+	£1.85
4	QUARTZ HANDS, BLACK, SPADE 105mm	0474 010515	1+	£2.03
			10+	£1.83
5	QUARTZ HANDS, BLACK, SPADE 137mm	0474 012715	1+	£2.58
			10+	£2.32
6	QUARTZ HANDS, BLACK, SPADE 177mm	0474 017715	1+	£3.25
			10+	£2.92
7	QUARTZ HANDS, BLACK, SPADE 195mm	0474 019515	1+	£8.75

HANDS FOR QUARTZ CLOCKS - SECOND HAND

I-shaft fitting. 5mm hour and 2.8 x 3.5mm minute.

Price per unit in £ on 13/06/2014

	SECOND HAND, RED WITH TAIL, overall: 135mm, centre to tip: 97mm	0475 009018	1+	£1.89
	QUARTZ SECOND HAND, BLACK, METAL, overall: 87mm, centre to tip: 60mm	0475 005202	1+	£1.16
			10+	£1.04
	QUARTZ SECOND HAND, GILT, METAL, overall: 87mm, centre to tip: 60mm	0475 005212	1+	£1.26
			10+	£1.13
	QUARTZ SECOND HAND, METAL, overall: 87mm, centre to tip: 60mm	0475 007018	1+	£1.45
			10+	£1.30

6. Hands

HANDS FOR QUARTZ CLOCKS - PLASTIC





I-shaft fitting, 5mm hour and 2.8 x 3.5mm minute.

Price per unit in £ on 13/06/2014

	PLASTIC QUARTZ HANDS BLACK 80mm X 10 PAIRS.	0474 000102	1+	£5.77
			2+	£5.19
	PLASTIC QUARTZ HANDS RED 80mm X 10 PAIRS.	0474 000118	1+	£4.96
			2+	£4.46
	PLASTIC QUARTZ HANDS BLUE 80mm X 10 PAIRS.	0474 000121	1+	£4.96
			2+	£4.46
	PLASTIC QUARTZ HANDS WHITE 80mm X 10 PAIRS.	0474 000123	1+	£4.96
			2+	£4.46
	PLASTIC QUARTZ HANDS YELLOW 80mm X 10 PAIRS.	0474 000125	1+	£4.96
			2+	£4.46
	PLASTIC SECOND HANDS RED 65mm X 10 PAIRS.	0475 000118	1+	£2.75
			2+	£2.47

HANDS FOR MINI QUARTZ MOVEMENT

Specifically to fit item, 1409 009515

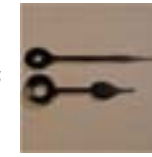
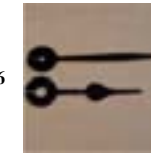
1		2		3		4		5		6		Call Harvey 24 Hours
---	---	---	---	---	---	---	---	---	--	---	---	-------------------------------------

Price per unit in £ on 13/06/2014

1	QUARTZ CLOCK HANDS FOR MINI MOVEMENT, Fancy, Gilt. Minute hand 25mm centre to tip. Hour hand 18mm. Hour collet 3.4mm round. Minute collet 1.9mm round.	1409 251818	1+	£10.90
2	QUARTZ CLOCK HANDS FOR MINI MOVEMENT, Fancy, Gilt, 33mm/24mm. Minute hand 33mm centre to tip. Hour hand 24mm. Hour collet 3.4mm round. Minute collet 1.9mm round.	1409 332418	1+	£6.49
3	QUARTZ CLOCK HANDS FOR MINI MOVEMENT, Spade, Gilt, 40mm/29mm. Minute hand 40mm centre to tip. Hour hand 29mm. Hour collet 3.4mm round. Minute collet 1.9mm round.	1409 402918	1+	£5.66
4	QUARTZ CLOCK HANDS FOR MINI MOVEMENT, Fleur de lys, Black, 28mm/20mm. Minute hand 28mm centre to tip. Hour hand 20mm. Hour collet 3.4mm round. Minute collet 1.9mm round.	1409 282002	1+	£5.99
5	QUARTZ CLOCK HANDS FOR MINI MOVEMENT, Spade, Black, 29mm/22mm. Minute hand 29mm centre to tip. Hour hand 22mm. Hour collet 3.4mm round. Minute collet 1.9mm round.	1409 292202	1+	£5.66
6	QUARTZ CLOCK HANDS FOR MINI MOVEMENT, Spade, Black, 40mm/29mm Minute hand 49mm centre to tip. Hour hand 29mm. Hour collet 3.4mm round. Minute collet 1.9mm round.	1409 402902	1+	£5.66

BRASS HAND PIPES

Brass tubing ideal for hand pipes on seconds hands. Packs of 5. Each length is 80mm.

Price per unit in £ on 13/06/2014

	BRASS HAND PIPE 5pcs 2.00mm O/D, 0.55mm I/D.	1445 020015	1+	£8.56
	BRASS HAND PIPE 5pcs 2.50mm O/D, 0.65mm I/D.	1445 025015	1+	£9.02
	BRASS HAND PIPE 5pcs 3.00mm O/D, 1.00mm I/D	1445 030015	1+	£10.17

MIXED HAND NUTS

Price per unit in £ on 13/06/2014

	MIXED HAND NUTS For American & cuckoo clocks. 12 assorted per pack.	0223 001215	1+	£7.17
---	---	-------------	----	-------

TURNED BRASS HAND WASHERS

For longcase and fusee clocks.

Price per unit in £ on 13/06/2014

	TURNED BRASS HAND WASHERS 9.5mm	0290 095015	1+	£0.42
			5+	£0.38
			Pack of 10	£0.34
		Pack of 30		£0.31
	TURNED BRASS HAND WASHERS 11mm	0290 110015	1+	£0.42
			5+	£0.38
			Pack of 10	£0.34
			Pack of 30	£0.31
	TURNED BRASS HAND WASHERS 13mm	0290 130015	1+	£0.42
5+			£0.38	
Pack of 10			£0.34	
Pack of 30			£0.31	

AMERICAN CLOCK WASHERS

Price per unit in £ on 13/06/2014

	AMERICAN CLOCK WASHERS Thick pressed brass. 30 assorted washers with round and square holes. Assortment.	1000 003015	1+	£3.34
---	--	-------------	----	-------

PRESSED HAND WASHER ASSORTMENTS

For French & German clocks. 1 gross containing 12 assorted sizes with round & square holes.

Price per unit in £ on 13/06/2014

	PRESSED HAND WASHER ASSORTMENT BLUE STEEL	0341 014421	1+	£22.80
	PRESSED HAND WASHER ASSORTMENT BRASS	0341 014418	1+	£22.80

6. Hands

ASSORTED HAND COLLETS

Price per unit in £ on 13/06/2014

	ASSORTED HAND COLLETS For fitting old or uncolleted hands to movements. Round & square holes.	0484 005815	1+	£20.82
---	--	--------------------	----	---------------













AMERICAN HAND COLLETS

Price per unit in £ on 13/06/2014

	AMERICAN HAND COLLETS Thin brass hand collets typical of those used on American clock hour hands. Easily fitted by passing through a 1/4" hole in the hand and riveting over the top. Sold in packs of 5.	0945 000515	1+	£3.46
---	--	--------------------	----	--------------

TURNED HAND COLLETS

See Catalogue appendix for more information.

1 	2 	3 	4 	5 	6 	7 
8 	9 	10 	11 	12 	13 	Call Harvey our Automated Sales line

Price per unit in £ on 13/06/2014

1	TURNED MINUTE HAND COLLET 2mm SQUARE Sold in packs of 5. Size is across the flats in mm.	0949 002015	1+	£5.30
2	TURNED MINUTE HAND COLLET 2.5 SQUARE Sold in packs of 5. Size is across the flats in mm.	0949 002515	1+	£5.30
3	TURNED HAND COLLET 3.0 ROUND Sold in packs of 5. Size is shaft diameter in mm.	0948 003015	1+	£5.30
4	TURNED HAND COLLET 3.5 ROUND Sold in packs of 5. Size is shaft diameter in mm.	0948 003515	1+	£5.30
5	TURNED HAND COLLET 4.0 ROUND Sold in packs of 5. Size is shaft diameter in mm.	0948 004015	1+	£5.30
6	TURNED HAND COLLET 4.5 ROUND Sold in packs of 5. Size is shaft diameter in mm.	0948 004515	1+	£7.92
7	TURNED HAND COLLET 5.0 ROUND Sold in packs of 5. Size is shaft diameter in mm.	0948 005015	1+	£7.92
8	TURNED HAND COLLET 5.5 ROUND Sold in packs of 5. Size is shaft diameter in mm.	0948 005515	1+	£5.30
9	TURNED HAND COLLET 6.0 ROUND Sold in packs of 5. Size is shaft diameter in mm.	0948 006015	1+	£5.30
10	TURNED MINUTE HAND FRENCH COLLET 2mm SQUARE Sold in packs of 5. Size is across the flats in mm.	0949 002018	1+	£5.78
11	TURNED HAND COLLET FRENCH 4.5mm ROUND Sold in packs of 5. Size is shaft diameter in mm.	0948 004518	1+	£5.78
12	TURNED HAND COLLET 3 x 4 QUARTZ OVAL Sold in packs of 10. For I-shaft quartz minute hands.	0950 000115	1+	£5.30
13	TURNED HAND COLLET 5.0 QUARTZ Packs of 5. Round. For I-shaft movements. Size is shaft diameter in mm.	0950 005015	1+	£4.46

Please do not send cheques or postal orders made out for what you think the total is

We do not accept cheques from non account holders for anything but the invoice total and this depends on current prices, availability etc. You can if you wish send a cheque crossed and made payable to Meadows & Passmore Ltd, but with the amount left blank. For your own safety write across the cheque (and on the back if you wish) "Not to exceed £....." and insert a figure about 10% higher than you think the total will be. We will make out the cheque for the correct amount and advise you of the total and send a receipt.

Remember, that if you feel the price we have charged for an item is excessive, you can return it (in a saleable condition with the invoice number) within 7 days for a refund. Alternatively, you can telephone during our office hours for the current cost of your order. If you do send a cheque for a fixed amount which does not match the invoice, whether it be higher or lower, it will be returned unprocessed.

We accept most major credit cards and debit cards. Cheques and postal orders are labour intensive, and we incur additional bank charges. Please use credit and debit cards whenever possible.

AUTOMATED SALES FREEPHONE

Most UK orders are sent postage free and despatched the same day if placed on our interactive order line.

0800 328 9435

Please call our sales office on 01273 421321 if you don't know your customer number and pin.

*Call before 3pm on weekdays for same day despatch. **Free postage only applies to UK orders, and not to heavy or bulky items such as books, fluids, domes etc. or very low value orders. Cannot be used in addition to other special discounts.

M&P's HorogreneTM.com

The Horological Green Cleaner

M&P's
3-Stage Clock
Cleaning System



- ✓ **No strong fumes**
- ✓ **No toxic chemicals**
- ✓ **Environmentally friendly**
- ✓ **Water soluble**
- ✓ **Quick and easy to use**
- ✓ **Kind to brass**

3-Stage cleaning system

125ml Kit contains enough to clean several clocks.

Degreasing concentrate

Lacquer remover

Surface cleaning concentrate

Plastic gloves

Full instructions



Using only non-toxic, non-flammable and non-ammoniated liquids, M&P's HorogreneTM Clock Cleaning Kit can be used safely in the home-workshop, in classrooms and public places etc. without creating unpleasant smells, fire hazards or toxic vapours.

For decades strong mixtures of solutions containing ammonia, flammable solvents and toxic chemicals have been used to clean clocks. Whilst effective, their toxic nature and pungent smells have become less appropriate in the home and workplace. Transporting hazardous fluids has become problematic, and inappropriate disposal of chemicals can affect the environment.

Please bear in mind that the purpose of the products in M&P's HorogreneTM is to strip off dirt, varnish and tarnish, and although they are not harmful, they will also remove natural oils from your skin. Avoid contact with skin whenever possible and wash your hands with soapy water at every opportunity. Consider the use of moisturising creams after use.

Use common sense. Keep out of reach of children and pets, and avoid contact with the eyes by splashing. None of the products is harmful to the environment and can all be disposed of down the drain in kit quantities.

How M&P's HorogreneTM works

A typical clock in need of restoration normally suffers from three distinct problems:

- The mechanism will have congealed oil mixed with dust and dirt over much of the surface
- Some parts may have been lacquered
- Parts not still lacquered may be tarnished

M&P's HorogreneTM is a 3-stage process, with each stage designed to resolve one of these problems. It is important to follow the instructions carefully and to carry out the stages in the correct order.

The amount of product to add to water is only a guide. For badly soiled parts, make the solution stronger, but not normally more than 15% concentrate. Excessively strong mixtures will not normally improve results.

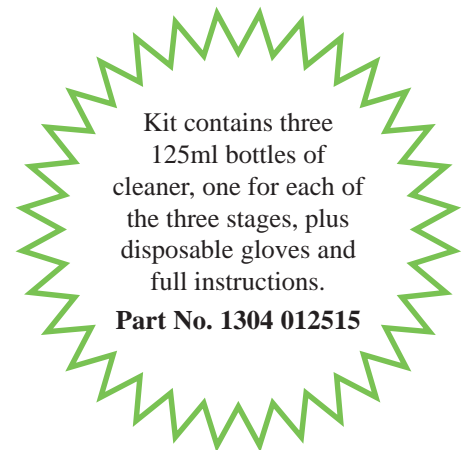

Kit contains three
125ml bottles of
cleaner, one for each of
the three stages, plus
disposable gloves and
full instructions.

Part No. 1304 012515